

M. P. Manahan, Sr.¹

In-situ Heating and Cooling of Charpy Test Specimens²

Reference: Manahan, M. P., Sr., “**In-situ Heating and Cooling of Charpy Test Specimens**”, *Pendulum Impact Testing: A Century of Progress, ASTM STP 1380*, T. A. Siewert and M. P. Manahan, Sr., Eds., American Society for Testing and Materials, West Conshohocken, PA, 1999.

Abstract: This paper presents an innovative approach to CVN and MCVN testing: the specimens are heated and cooled on the test machine itself. This approach is not only cost-effective but is technically superior to methods requiring transfer of the test specimen to the test machine from a thermal conditioning bath because the specimen is very accurately centered and is thermally conditioned up to the moment of impact. The system developed is capable of thermally conditioning both CVN and MCVN specimens over the temperature range of -180°C # T # 315°C. Advanced systems are under development which will extend this temperature range. This paper presents data obtained using the in-situ heating and cooling system and compares the results with specimens which were heated and cooled using a liquid bath transfer approach. Specimens instrumented with embedded thermocouples were used to characterize the heat loss during bath transfer and to compare with the uniform temperature field produced by the in-situ system. Measurements are also presented which show a factor-of-two improvement in specimen alignment can be easily achieved with the in-situ system centering tool.

Keywords: impact testing, Charpy test, instrumented striker, absorbed energy, miniaturized Charpy testing, specimen thermal conditioning

Introduction

Charpy V-notch (CVN) tests to characterize the transition region and upper shelf energy require heating and cooling of the test specimen. The conventional approach is to use an apparatus separate from the test machine such as an oil bath to heat and an alcohol/dry ice bath to cool the test specimens. ASTM E 23 requires that the specimens be held in an agitated liquid bath within $\pm 1^\circ\text{C}$ for at least 5 minutes before transferring the specimen to the test machine. More recently, some laboratories which test radioactive specimens have developed gas heating and cooling chambers which circulate gas around the test specimens to thermally condition them prior to transfer to the test

¹ President, MPM Technologies, Inc., 2161 Sandy Drive, State College, PA 16803.

² The information contained in this paper is covered by US Patent Number 5,770,791 and is the property of Dr. M. P. Manahan, Sr..

machine. ASTM Test Methods for Notched Bar Impact Testing of Metallic Materials (E 23) requires that the gas circulate around test specimens within $\pm 1^\circ\text{C}$ for at least 10 minutes prior to transferring them to the impact test machine. Irrespective of the means used to thermally condition the test specimen, E 23 recommends the use of self-centering tongs to place the specimen on the supports against the anvils and requires that the specimen be broken within 5 seconds after removal from the thermal conditioning medium. Allowing for an approximate 1 second hammer swing to contact the specimen, the specimen must be transferred to the test machine within 4 seconds, and this is achievable by individuals with moderate hand-eye coordination for CVNs using transfer tongs. However, when testing miniaturized Charpy V-notch (MCVN) specimens, the heat losses are unacceptably large over the time interval which can be achieved manually. An example of the average temperature change measured for CVN and MCVN specimens after removal from a liquid bath is given in Table 1. The data illustrate that for CVN specimens a 3.5°C temperature increase has occurred at the specimen surface 5 seconds after removal from the -40°C bath. As expected, the internal specimen temperature change is negligible. However, the surface temperature change is not desirable because it can affect the crack initiation at the root of the notch.

As shown in Table 1, both the surface and bulk material temperature changes are unacceptably large for the MCVN specimens. To overcome this, some laboratories have built robotic transfer systems which can transfer the specimen to the test machine within 1-2 seconds. However, these systems are often unreliable and are very expensive. An alternative to robotic transfer is to thermally soak the specimen on the specimen support up to the moment of impact, and this approach is the subject of this paper. Although the initial impetus for the development of this new technology was MCVN applications, the improvement in temperature control and specimen alignment make the technology very attractive for CVN testing as well.

Experimental Configuration

The experimental configuration is shown in Figure 1. Test specimens are thermally preconditioned in-situ by flowing a thermally conditioned gas over the surfaces of the specimen which contain the volume of material near the notch which influences fracture properties (fracture process volume). Depending on the temperature range of interest, it is desirable in some instances to thermally precondition the test fixture as well.

The key element of the approach is to ensure that the fracture process volume is thermally conditioned. Figure 2 shows the extent of the plastic zone in a Charpy specimen as a function of applied load. These data were obtained by performing three dimensional finite element analyses [1]. Normalizing the applied load by the general yield load makes the results applicable to other yield stress levels. It can be seen in the figure that the plastic zone extent peaks at about one specimen height. Therefore, the fracture process zone extends along the axis of the specimen 10 mm on either side of the crack plane. This volume of material must be kept at the desired test temperature up to the time when the striker contacts the specimen.

Table 1-Example of the Average Temperature Change in Miniature and Conventional Charpy Specimens after Removal from a Liquid Bath

Specimen Type	Time After Removal from Bath (seconds)	Bath Temperature (°C)	Average Temperature Change at Specimen Surface (°C)	Average Temperature Change at Specimen Crack Plane Near Notch (°C)
CVN	5	-40	3.5	0.2
MCVN	5	-40	12.1	3.8

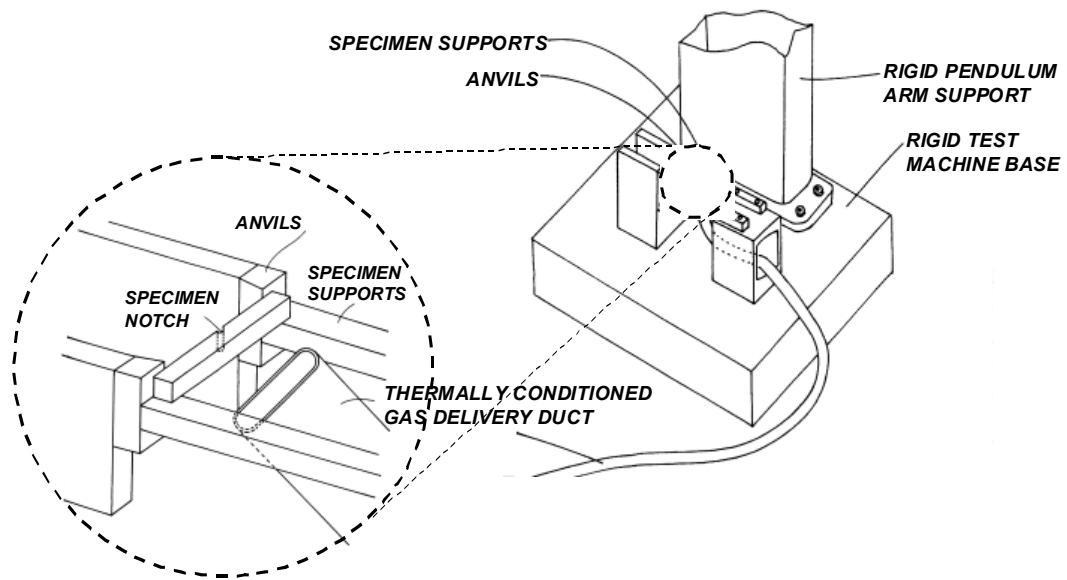

Figure 1-Schematic Representation of In-situ Heating and Cooling System for Charpy Impact Test

In-situ Heating/Cooling Test Results

Measurements using specimens instrumented with thermocouples (see Figure 3) have demonstrated that the desired test temperature can be reached within 10 minutes for most test cases. In the most limiting case studied, a test specimen instrumented with thermocouples started cooling at room temperature and reached a set point of -190°C (liquid nitrogen temperature) within 15 minutes. This is comparable to the time required for a liquid bath to reach its setpoint. The desired test temperature (within $\pm 1^{\circ}\text{C}$) was maintained within the specimen up to the moment of impact. The current ASTM E 23 impact test standard requires the thermal conditioning bath to be held within $\pm 1^{\circ}\text{C}$ for at least 5 minutes before the specimen is transferred to the test machine, and the specimen must be struck within 5 seconds of removal from the bath. Thus, the current in-situ system meets the ASTM requirement because the specimen is thermally conditioned to within $\pm 1^{\circ}\text{C}$ right up to the time of impact. As mentioned earlier, the conventional bath transfer approach results in changes in the specimen temperature after the specimen is removed from the bath (an example is shown in Table 1). The magnitude of the specimen temperature change after removal from a liquid bath is dependent on the bath temperature. The larger the temperature difference relative to room temperature, the larger the specimen temperature change.

The data obtained for the case where the specimen was cooled to -190°C is given in Figure 3. The B1 thermocouple is an internal thermocouple which was placed at approximately the edge of the plastic zone which is generated during loading. The B2 thermocouple is also an internal thermocouple which was placed at the crack plane just below the notch. As shown in Figure 3, the surface thermocouples were placed in analogous positions. The most important thermocouple readings are the internal thermocouples B1 and B2. These thermocouples read within 0.3°C of each other. As shown in the figure, the surface thermocouples are also in very close agreement with the internal thermocouples. The excellent agreement between the surface temperature and the internal specimen temperature is achieved by bathing the specimen in a thermally controlled flow of liquid nitrogen vapor.

In order to completely validate the in-situ heating and cooling technology, full size CVN specimens were tested using the in-situ system and the results were compared with test results obtained using the conventional liquid bath approach. The results of these tests are shown in Figure 4. The material tested is a modified A302B reactor pressure vessel steel referred to as plate G-8-3. This plate is a beltline plate in the Nine Mile Point Unit 1 nuclear plant. The specimens were cut from an archive prolongation at a depth of one quarter of the plate thickness ($\frac{1}{4} T$ location). The orientation of the specimens tested is transverse-longitudinal (TL).

Full Charpy transition curves were developed by Battelle and by MPM Technologies, Inc. (MPM) using the conventional liquid bath approach. The Battelle and MPM data were fit using the FRACTURE/FIT program [2]. The software used to fit the Charpy data provides two alternative fitting functions: the first is a hyperbolic tangent function with four fitting parameters; and the second is a polynomial of order two (three fitting parameters). The hyperbolic tangent function was used for this study. In addition to fitting the mean energy versus temperature trend, the software can also simultaneously fit the data with a three parameter Weibull statistical distribution. This Weibull distribution

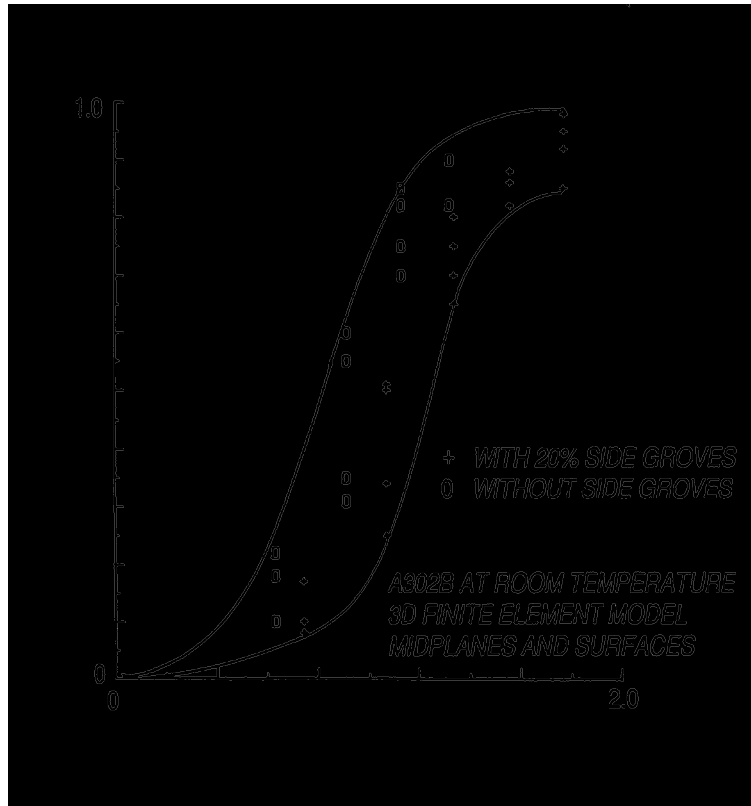

Figure 2-Plastic Zone Size Results from 3D Finite Element Simulations of Charpy Specimens (+s are for midplane and Os are for free surfaces)

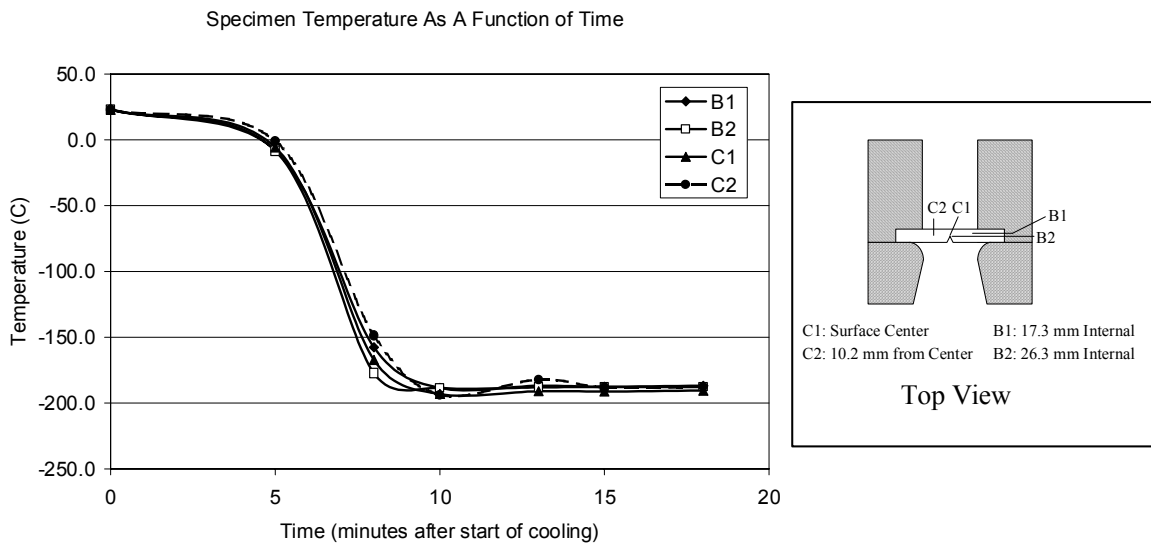

Figure 3-Plot of Specimen Temperature as a Function of Time Obtained Using the In-situ System. The Plot Shows that the Specimen Attains the Setpoint Temperature of -190°C within 15 Minutes.

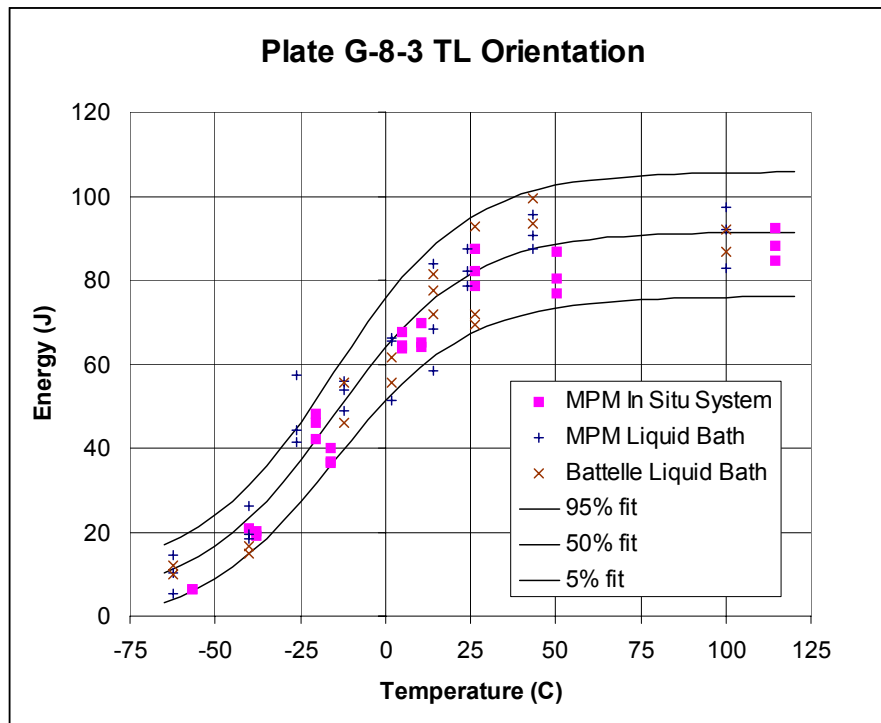

Figure 4-Comparison of CVN Data Obtained Using Conventional Liquid Bath and In-situ Heating and Cooling System for Plate G-8-3 in the As-Received Condition

is temperature dependent and the 50% probability level of the distribution is, by definition, the mean trend fit. A Weibull parameter of 4 was used which defines a Gaussian distribution of the measured energies at each test temperature. Since few data points were measured near the lower shelf, the mean lower shelf energy was set at 4 J.

The results of the fitting are given in Figure 4. The fit was performed using the liquid bath data only and the in-situ data were plotted for comparison with the liquid bath data. As shown in the figure, the in-situ data are within the scatter of the liquid bath data and within the confidence intervals calculated by FRACTURE/FIT. It has been concluded that the in-situ technology is validated and can be used routinely for CVN and MCVN testing.

Specimen Alignment

The in-situ heating and cooling technology significantly reduces the uncertainty associated with thermal losses during transfer of the test specimen from the bath to the test machine. This approach also creates the opportunity for improvement of the alignment of the specimen in the test machine. The current procedure, which is widely accepted, is to use centering tongs to center the notch relative to the plane of the pendulums arc. ASTM E 23 requires that the notch be centered to within 0.25 mm. A centering tool has been developed which is easy to use and which is more accurate than centering tongs.

In order to quantify the accuracy of centering using tongs and an in-situ centering device, CVN test specimens were placed on the specimen supports 50 times each. A closed circuit television camera was placed over the test machine supports and anvils and used to measure the position of the root of the notch relative to the anvils. The data are given in Figures 5 through 7. The measurements were made from the left anvil to the center of the notch (labeled “A” in the figures) and from the right anvil to the center of the notch (labeled “B” in the figures). These measurements were averaged and the standard deviation for the 50 individual measurements was calculated (see Table 2).

As shown in Figure 5, the two standard deviation for centering using the tong method is 0.11 mm, and this is within the ASTM allowable uncertainty of 0.25 mm. Figures 6 and 7 illustrate that the in-situ centering tool enables a significant improvement in the notch centering. As shown in Table 2, the in-situ CVN centering tool improved the specimen centering uncertainty by about a factor of 2. Figure 7 and Table 2 show that the MCVN specimens can be centered to the same level of accuracy as for the CVNs using the in-situ centering tool.

An important concern related to centering of the test specimens is the adequacy of the current E 23 ± 0.25 mm centering range. A preliminary investigation indicates that the current centering range may be too large, however, an in-depth investigation will be needed in the future to quantify the appropriate range for the E 23 standard. The data from the preliminary investigation is presented in Tables 3 through 6. Tables 3 and 4 present data from tests conducted using the LL-68 material from the ASTM Instrumented/Miniaturized Round Robin Test Program, and Tables 5 and 6 present data for the HH-71 material from the same program. Tables 3 and 5 report data for accurately centered specimens (centered using the in-situ centering tool) and Tables 4 and 6 report data for specimens tested with the center of the notch offset from the plane of the pendulums arc by 0.25 mm. In the case of the LL-68 material, the trend indicates a lower absorbed energy for the offset specimens while the opposite trend is observed for the HH-71 material. Although the energy average is within the two sigma range, the energy differences observed are significant. It is also interesting to note that the shear lip data for the LL-68 material show a trend toward a right-left (one shear lip on each specimen half) configuration. The right-left configuration tends to result in high absorbed energies for the centered specimens. This effect should be studied in the future using larger sample populations.

Conclusions

The in-situ heating and cooling technology offers significant technical advantages over the conventional bath transfer method and it offers significant cost advantages over complicated robotic transfer systems. The impact energy results obtained from CVN tests using the in-situ approach have been shown to be well within the scatter of energies obtained using the liquid bath approach. The in-situ technology significantly reduces the uncertainty associated with thermal losses during transfer of a test specimen from the bath to the test machine. For example, conventional CVN specimen surface temperatures increase 3.5 °C within 5 seconds after removal from a -40°C liquid bath. Measurements using specimens instrumented with thermocouples have demonstrated that the desired test temperature can be reached using the in-situ system within about 10 minutes for most

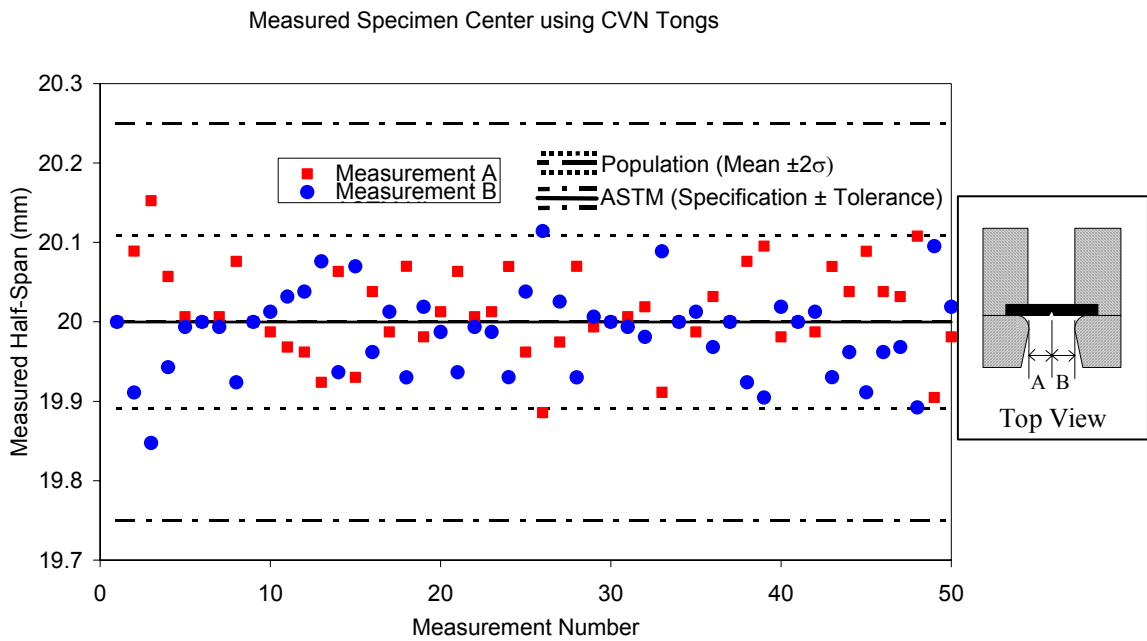

Figure 5-*Conventional Charpy Specimen Centering Using Tongs*

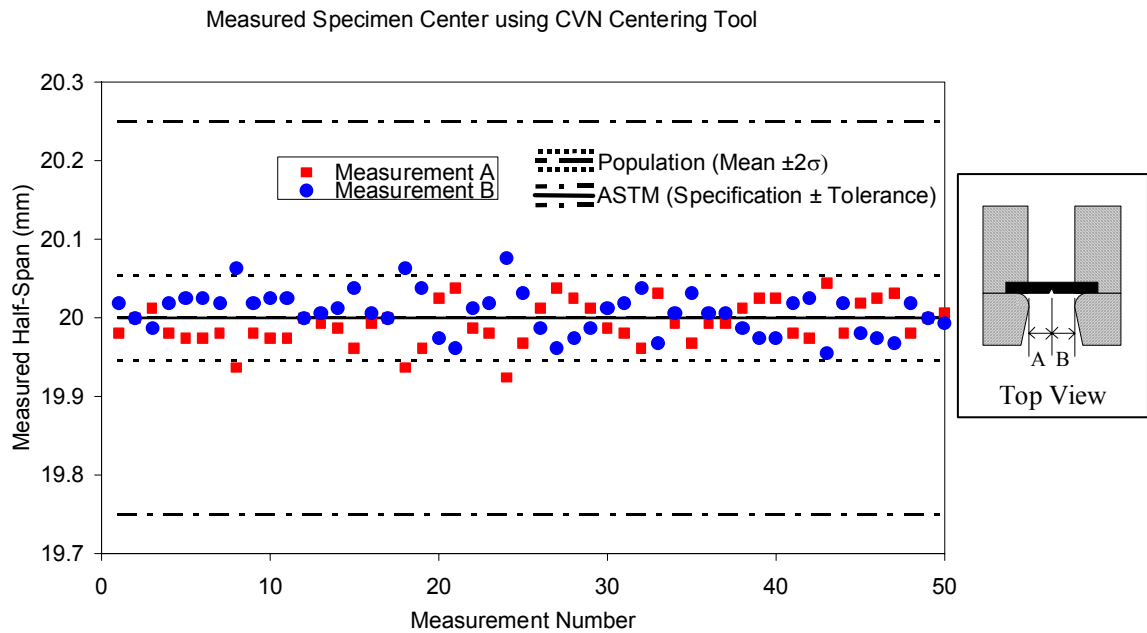

Figure 6-*Conventional Charpy Specimen Centering Using In-situ CVN Centering Tool*

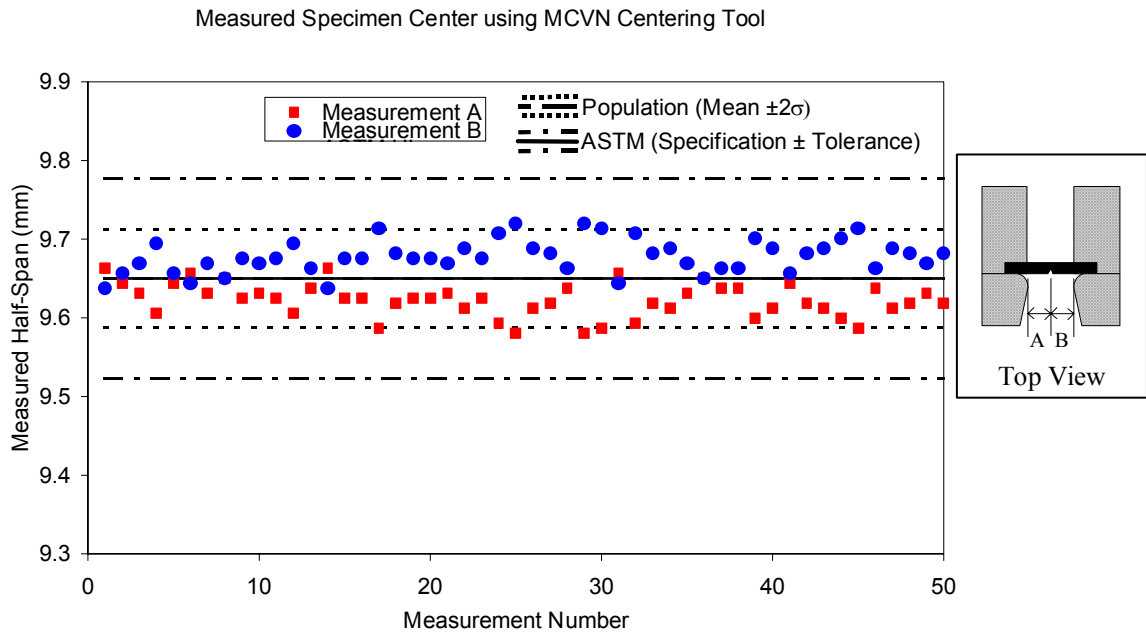

Figure 7-Miniature Charpy Specimen Centering Using In-situ MCVN Centering Tool

Table 2-Summary of Specimen Centering Results for Conventional Tongs and In-situ Centering Tool

Centering Device	Measurement "A" Mean (mm)	Measurement "B" Mean (mm)	"A" Standard Deviation (mm)	"B" Standard Deviation (mm)	<p style="text-align: center;">Top View</p>
CVN Tongs	20.014	19.986	0.055	0.055	
CVN In-situ Tool	19.993	20.007	0.027	0.027	
MCVN In-situ Tool	9.622	9.678	0.021	0.021	

Table 3-Results from Centering Study Using Centered Low Energy 4340 Test Specimens

Specimen Identification	Impact Energy (J)	Brittle Fracture Load (kN)	Shear Lip Configuration (OS/RL)
LL68-154	27.02	35.86	RL
LL68-376	28.12	37.29	RL
LL68-463	25.63	36.58	OS
LL68-531	26.25	35.53	RL
LL68-564	24.31	35.53	OS
LL68-1175	23.00	35.23	OS
Average	25.72	36.00	
StDev	1.848	0.781	

Notes: Test temperature 20°C, 8 mm striker radius, impact velocity 5.47 m/s. Shear lip locations: one-sided (OS) indicates one specimen half has both shear lips, or right-left (RL) indicates one shear lip on each specimen half.

Table 4-Results from Centering Study Using Offset Low Energy 4340 Test Specimens

Specimen Identification	Impact Energy (J)	Brittle Fracture Load (kN)	Shear Lip Configuration (OS/RL)
LL68-191	23.01	35.20	OS
LL68-749	23.09	37.06	RL
LL68-788	23.01	35.88	RL
LL68-860	23.71	35.43	RL
LL68-925	24.63	37.14	RL
LL68-1010	24.25	37.36	RL
Average	23.62	36.35	
StDev	0.698	0.952	

Notes: Test temperature 20.9°C, 8 mm striker radius, impact velocity 5.47 m/s. Specimens offset 0.25mm from centered position. Shear lip locations: one-sided (OS) indicates one specimen half has both shear lips, or right-left (RL) indicates one shear lip on each specimen half.

Table 5-Results from Centering Study Using High Energy Centered 4340 Test Specimens

Specimen Identification	Impact Energy (J)	General Yield Load (kN)	Peak Load (kN)	Deflection at Peak Load (mm)	Shear Lip Configuration (OS/RL)
HH71-139	123.46	18.90	25.71	2.265	RL
HH71-209	107.99	18.32	24.74	2.116	OS
HH71-473	112.25	17.63	25.20	2.042	RL
HH71-521	114.39	18.48	24.85	2.217	OS
HH71-936	114.21	18.99	25.44	1.973	RL
HH71-1027	118.03	18.70	25.51	2.115	RL
Average	115.06	18.50	25.24	2.121	
StDev	5.262	0.496	0.384	0.108	

Notes: Test temperature 20.8°C, 8 mm striker radius, impact velocity 5.47 m/s. Shear lip locations: one-sided (OS) indicates one specimen half has both shear lips, or right-left (RL) indicates one shear lip on each specimen half.

Table 6-Results from Centering Study Using High Energy Offset 4340 Test Specimens

Specimen Identification	Impact Energy (J)	General Yield Load (kN)	Peak Load (kN)	Deflection at Peak Load (mm)	Shear Lip Configuration (OS/RL)
HH71-239	113.40	18.55	24.87	2.131	OS
HH71-351	119.46	18.98	25.72	2.165	RL
HH71-479	119.65	18.90	25.49	2.061	RL
HH71-904	123.11	18.73	25.52	2.253	OS
HH71-996	126.31	18.83	25.59	2.222	RL
HH71-1080	116.66	18.64	25.38	2.251	OS
Average	119.77	18.77	25.43	2.181	
StDev	4.567	0.162	0.296	0.076	

Notes: Test temperature 20.8°C, 8 mm striker radius, impact velocity 5.47 m/s. Specimens offset 0.25 mm from centered position. Shear lip locations: one-sided (OS) indicates one specimen half has both shear lips, or right-left (RL) indicates one shear lip on each specimen half.

cases of interest. The current ASTM E 23 test standard requires the specimen to be struck within 5 seconds of removal from the bath. The in-situ system meets the ASTM requirement because the specimen is thermally conditioned to $\pm 1^\circ\text{C}$ right up to the time of impact. Further, the in-situ system reduces surface temperature changes to within $\pm 1^\circ\text{C}$. This provides a significant improvement over the current approach of transferring the thermally conditioned specimen to the test machine because in the current method large surface temperature changes occur which can influence the crack formation energy.

The in-situ approach also creates the opportunity for improvement of the alignment of the specimen in the test machine. The current ASTM method is to use centering tongs to center the notch relative to the center of the pendulums arc. An in-situ centering tool has been developed which is much more accurate than centering tongs. Measurements made to quantify the specimen centering have shown that the in-situ centering tool can reduce the uncertainty in specimen centering using tongs by about a factor of two. Preliminary data indicate that the current E 23 test specimen centering range of ± 0.25 mm is too large and should be reduced. Additional research will be needed to quantify the acceptable range for the E 23 standard.

References

- [1] Manahan, M. P., Sr., Stonesifer, R. B., Soong, Y., Burger, J. M., "Miniaturized Notch Test Specimen and Test Machine Design," *Pendulum Impact Machines: Procedures and Specimens for Verification*, ASTM STP 1248, edited by T. A. Siewert and A. K. Schmieder, American Society for Testing and Materials, West Conshocken, PA, pages 39-69, 1995

- [2] "FRACTURE/FIT: Weibull Based Fracture Fitting Code", MPM Technologies, Inc., 1997